

たばこ

かた・どうたいの中でじくをうける

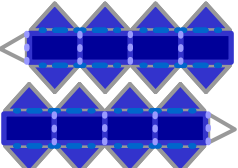

かたじく・を

13

ロボットの作り方
http://robo-t.com
robo-t@robo-t.com

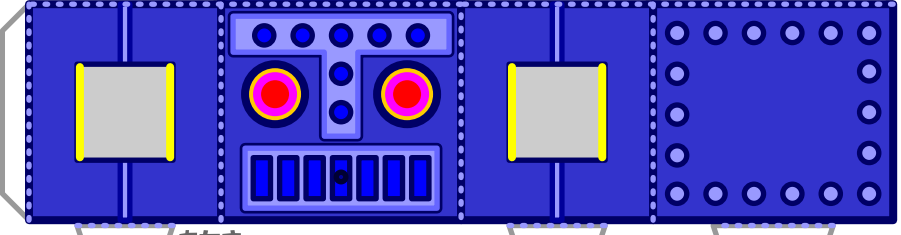
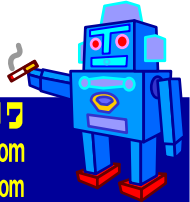

あたま

どうたい

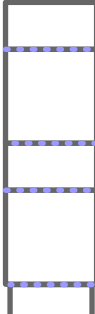
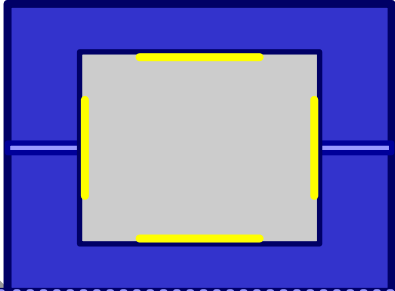

あし (中)

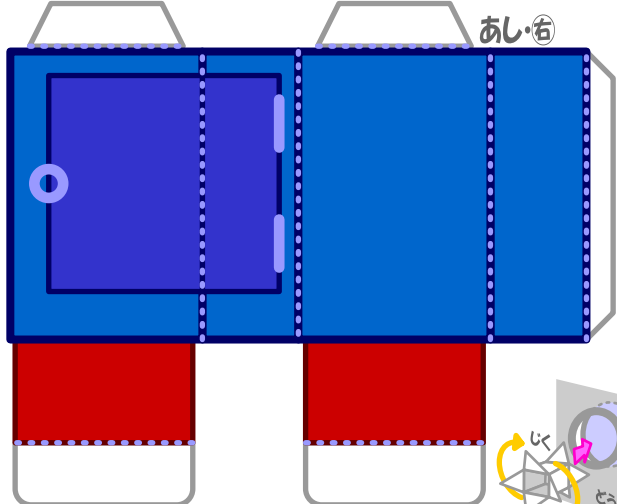
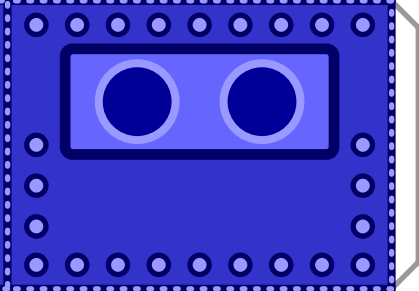
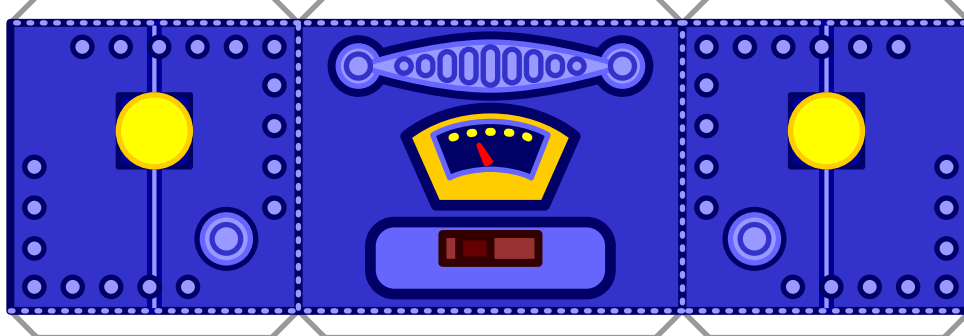

あし・右

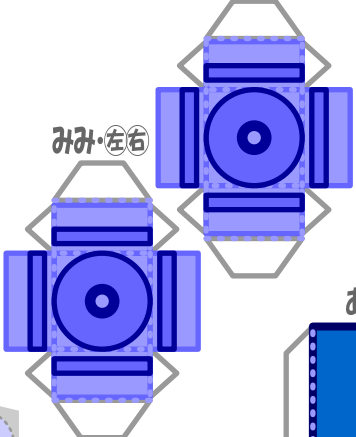

めい・右

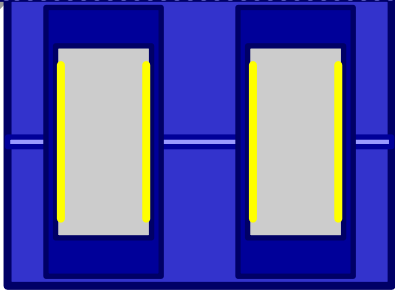

あし・左

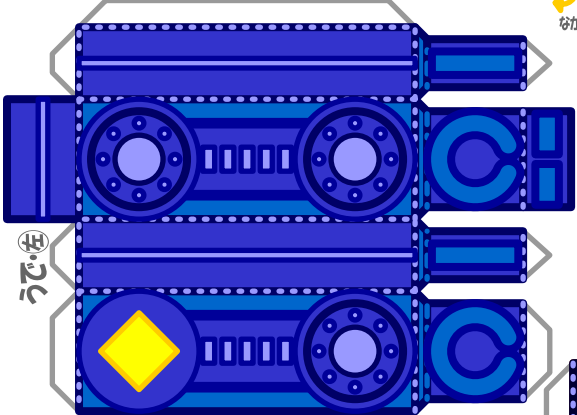
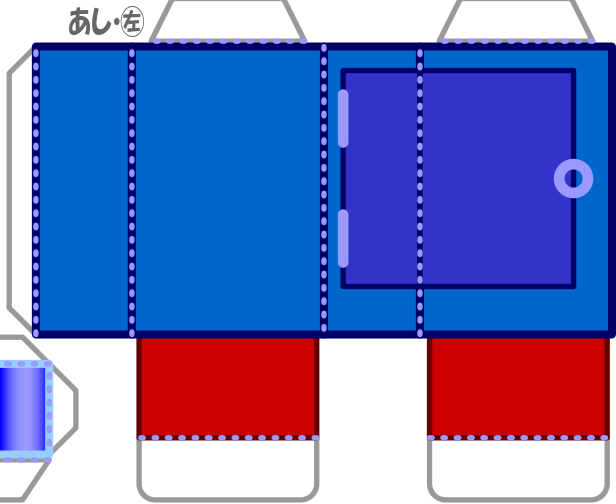

うで・右

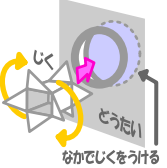

かたでじくをうける

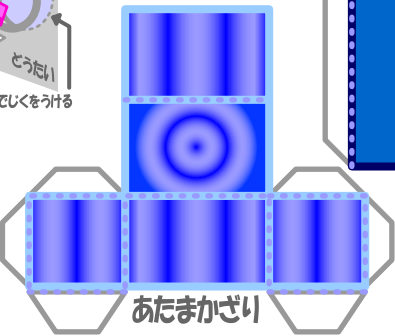

あたまかざり

あし・左

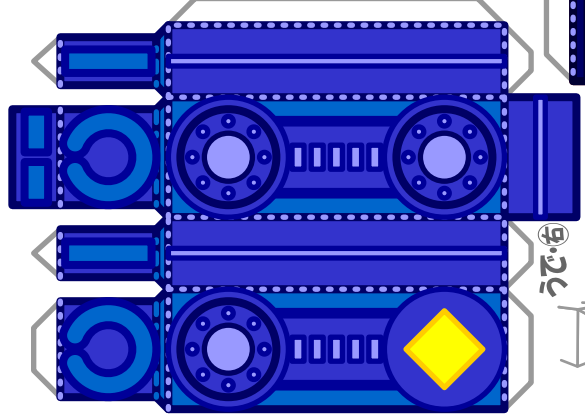

うで・左

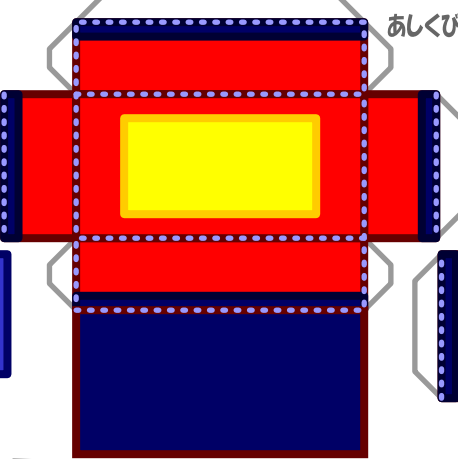

あし・右

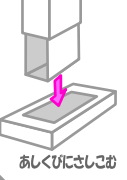
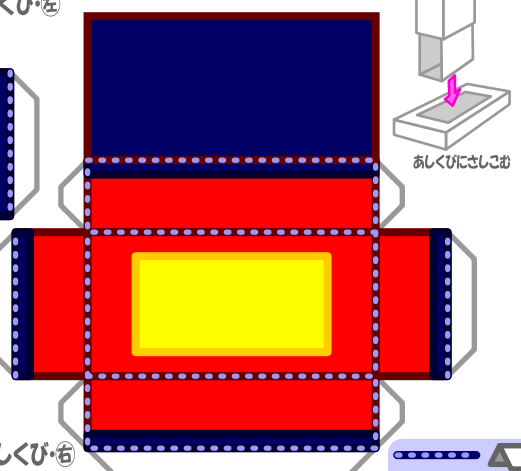

あし・右



てくび (中) を入れて接着する

